

## 1 Ton Underhung Motorized End Trucks Single Girder up to 34ft Span 220/440V 3P

### Características Esenciales

- I Beam and H Beam Compatible, Customizable up to 12" width Beams
- Kit Includes 2 End Trucks, 4 motors, 4 reducer, 4 Brakes
- Dual Voltage 220/440V 3 Phase, Optional Variable Speed Driver
- Fully Painted Orange RAL2009

## Especificaciones Técnicas

<b>Capacidad de Carga</b>	1 ton	<b>Velocidad /min</b>	66 ft
<b>Numero de Velocidades</b>	1 Speed - Optional Variable Speed	<b>Voltaje</b>	3 Phase 240/480V 60Hz
<b>Luz Maxima</b>	50 ft	<b>Material</b>	Steel
<b>Clase de Servicio</b>	H4/M5/2m/Class D	<b>Protección IEC Motor</b>	IP54
<b>Normas</b>	ASME / CMAA / Nch	<b>Garantía</b>	3 Year
<b>Largo de testera</b>	1500 mm		

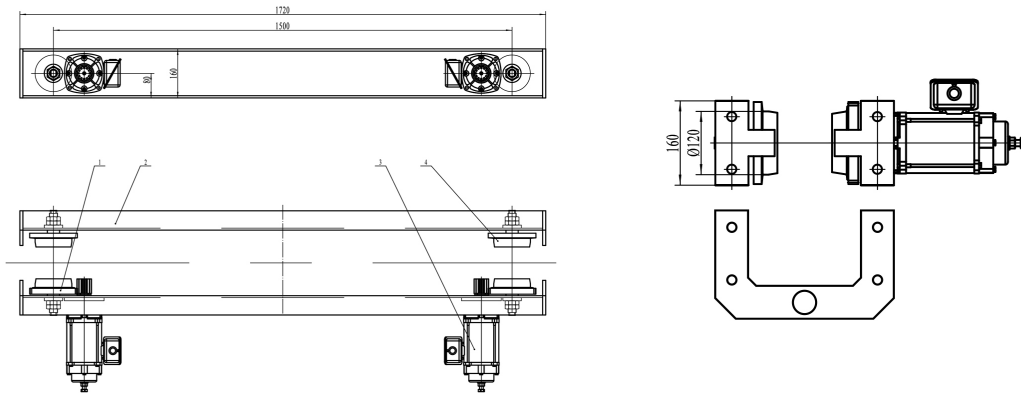

## Peso & Dimensiones

**Peso Total**

596 lbs / 271 Kg

Referential Images / Imágenes Referenciales  
Specifications may change without notice / las especificaciones pueden cambiar sin previo aviso