

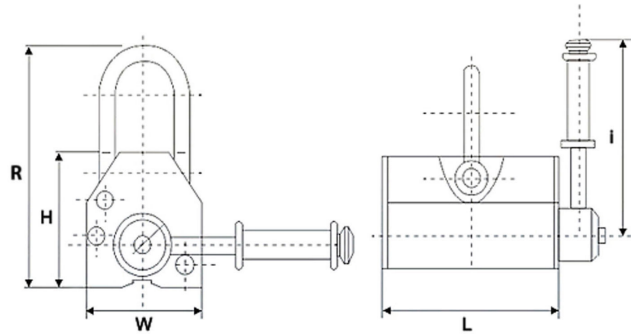

Permanent Magnetic Lifter 220 lb. / 100 kg

Especificaciones Técnicas

Capacidad de Carga	220 lb / 100 kg Max. pull off: 660 lb / 300 kg	Prueba de Carga	300
Material	steel and NdfеB-N45	Factor de Diseño	3
Normas	EN 13155:2003 A2:2009	Garantía	3 Year
Standards Certified	EN 13155:2003 A2:2009	1st Package Type	CTN



Model/Modelo	PWML100	PWML400	PWML600	PWML1000	PWML2000	PWML3000	PWML4000	PWML5000
L	4 in / 90 mm	6 in / 160 mm	9 in / 220 mm	10 in / 260 mm	13 in / 340 mm	17 in / 420 mm	19 in / 480 mm	23 in / 580 mm
W	3 in / 63.5 mm	4 in / 95 mm	5 in / 115 mm	6 in / 145 mm	6 in / 160 mm	7 in / 185 mm	8 in / 200 mm	12 in / 300 mm
H	3 in / 68 mm	7 in / 180 mm	5 in / 125 mm	6 in / 145 mm	6 in / 165 mm	7 in / 185 mm	8 in / 200 mm	12 in / 300 mm
R	6 in / 145 mm	8 in / 210 mm	9 in / 230 mm	11 in / 280 mm	16 in / 410 mm	20 in / 510 mm		26 in / 650 mm
Magnet Activation	Locking ON/OFF Handle							
Activación del magneto	Palanca ON/OFF							

Peso & Dimensiones

Peso Total

8 lbs / 4 Kg

Referential Images / Imágenes Referenciales
 Specifications may change without notice / las especificaciones pueden cambiar sin previo aviso