

Dinamometro a cable de Acero 1 Ton IP68

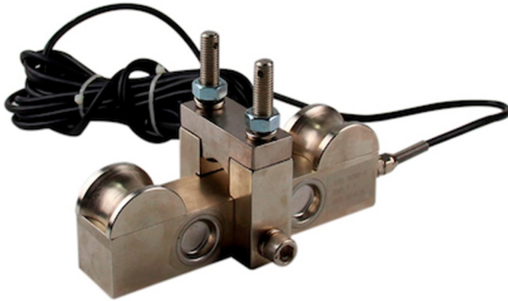

Especificaciones Técnicas

Scale Accuracy	± 0.3%	Scale Graduations	Alloy
Weighing Units	kg and lb	Temp. Range	-4° to 122°F (-20° to 50°C)
Max Capacity	1 ton	Intervalos de Medición	1/2/5/10/20/50 lb/kg
Frecuencia de Muestro (por seg)	80 times per sec	Peso Mínimo	1 lb
Balance Cero	±1% FS, TCO = ±0.05% FS 50 °F / 10 °C	Factor de Diseño	4:1
Normas	ASME B30.26-6; OSHA 29CFR1910 Subpart N; OSHA 29CFR1910.179	Garantía	3 Year

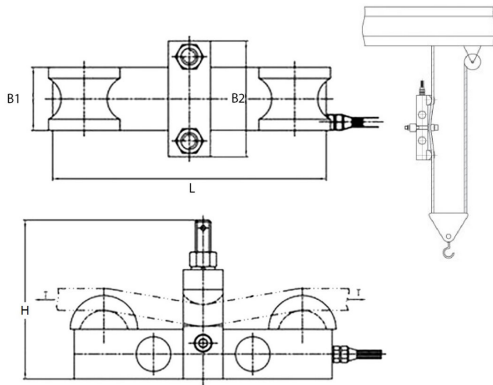

Capacity / Capacidad	H	B1	B2	L	Steel Rope/Cable de Acero
2000 lb / 1 t	3.8 in / 95.5 mm	1.6 in / 40 mm	2.4 in / 60 mm	7.1 in / 180 mm	ø1/4 - ø5/16 in ø6 - ø14 mm
4000 lb / 2 t	3.8 in / 95.5 mm	1.6 in / 40 mm	2.4 in / 60 mm	7.1 in / 180 mm	ø25/64 - ø54/64 in ø10 - ø18 mm
6000 lb / 3 t	3.8 in / 95.5 mm	1.6 in / 40 mm	2.4 in / 60 mm	7.1 in / 180 mm	ø15/32 - ø25/32 in ø12 - ø20 mm
10000 lb / 5 t	5.4 in / 136.5 mm	1.6 in / 40 mm	2.9 in / 75 mm	7.9 in / 200 mm	ø5/8 - ø1 1/32 in ø16 - ø26 mm
20000 lb / 10 t	7.7 in / 195 mm	2.4 in / 60 mm	4.3 in / 110 mm	10.2 in / 260 mm	ø15/16 - ø1 13/32 in ø24 - ø36 mm
50000 lb / 25 t	By Request Customizable / Adaptable Según Pedido				
100000lb / 50 t	By Request Customizable / Adaptable Según Pedido				

Referential Images / Imágenes Referenciales
 Specifications may change without notice / las especificaciones pueden cambiar sin previo aviso