



Mordaza Para Viga 3 Ton

Especificaciones Técnicas

Capacidad de Carga

3 Ton / 6600 lbs. | Test Load: 1.5
Rated Load

Rango de ancho de la Viga

80 ~ 320mm | 3.15 ~ 12.6 in

Garantía

3 Year

Working Load	I-Beam Width	A Max.	B		C	D	E	F		G	H
			Min.	Max.				Min.	Max.		
2200	3 - 8.5	10.25	7	14	2.5	0.19	8.5	4	6.1	1	0.86
4400	3 - 8.5	10.25	7	14	3	0.23	8.5	4	6.1	1	0.86
6600	3 - 12.5	14	9.25	19.25	4	0.31	10.2	5.5	8.85	1.8	0.94
11000	3 - 12.5	14	9.25	19.25	4.3	0.4	10.2	5.5	8.85	1.8	1.1

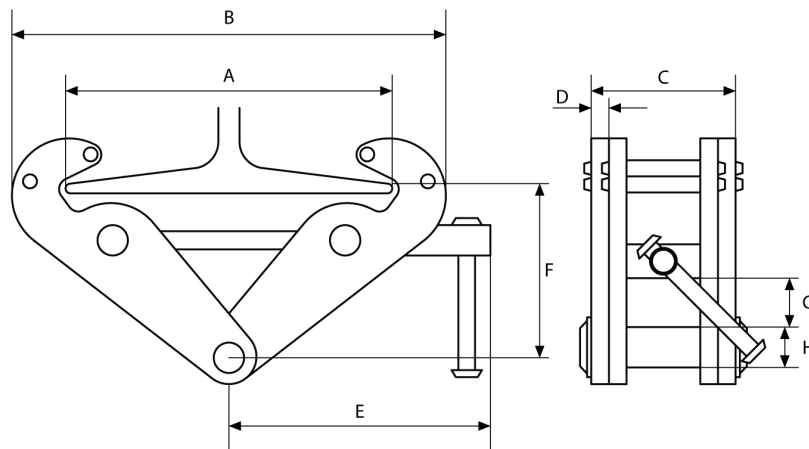

Peso & Dimensiones

Peso Total

22 lbs / 10 Kg

Referential Images / Imágenes Referenciales

Specifications may change without notice / las especificaciones pueden cambiar sin previo aviso